

MZX-LED Fluorescence Module



The stereo digital fluorescence module can match the Galileo optical system stereo microscopes of major brands Olympus, Nikon, Leica and Zeiss, enabling ordinary microscopes to realize fluorescence function without changing the original optical path of the microscope, and easily realize the fluorescence observation function for ordinary microscopes. The dual-color three-channel design can meet the observation needs of up to 3 colors of fluorescence, and can be equipped with relevant bands including

V/B/G/Y/R, and a supporting digital display screen design to meet the requirements of quantitative experiments, making the brightness adjustment more controllable. In addition, the light field of view has been expanded, and the compatibility with the microscope is higher than before.

Applied applications

Biological live imaging, Nematode, Chick CAM, Drosophila, Zebrafish, Embryo, Forensic investigation

Features

- ✓ Compact design contains light source and filters in one unit.
- ✓ Instant on-off, no need waiting of pre-heating or cooling.
- ✓ Unique dual light path design, higher and more uniform brightness.
- ✓ Two-color three-channel structure design, standard configuration of two large-view fluorescence channels and one bright field channel for external bright field lighting to pass
- ✓ Digital screen shows light intensity 0~100% of each channel.
- ✓ Memory function of last fluorescence lighting intensity individually.
- ✓ No requirement of external or added power supply.
- ✓ Linked rotating knob move filter cubes and light source by one step
- ✓ CE, FCC, EMC, EU, ISO certified.

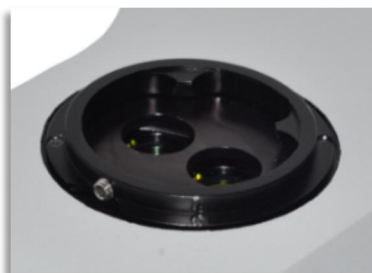

Dual light path design



Rotating knob links light source and filter cubes moving together



Digital screen shows channel and light intensity with memory function

Dimension & Installation photo

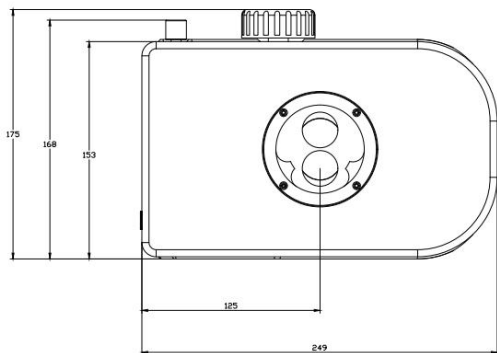
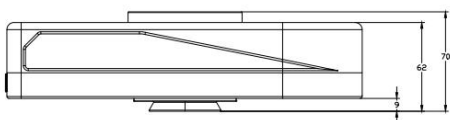

Specification

Types	Item No.	Excitation groups	Filter Groups	Compatible microscopes	
2 channels	MZX-BG-LED / MZX-BY-LED	BG/BY	BG/BY	Olympus SZX Nikon SMZ Leica M	
3 channels	MZX-BGV-LED / MZX-BYU-LED	BGV/BYV	BGV/BYV	Zeiss V/Discovery/SV Sunny SZX12 Motic SZM7	
Standard LED lamp and Filters					
Model	LED lamp	Filter wavelength			Mainly Applied Fluorochrome
	Color	Excitation filter	Dichroic mirror	Emission filter	
B	Blue	475/40nm	505nmLP	525/45nm	GFP/ FITC /EGFP
G	Green	530/40nm	570nmLP	590nmLP	PI / EB / EH /TRITC
Y	Yellow	560/40nm	600nmLP	610nmLP	Mcherry/TexasRed/Alexa Fluor 594
V	Violet	400/40nm	430nmLP	460nmLP	CFP/part of DAPI
Light source	Blue: 6W LED for each filter group, 3W per LED lamp Green: 12W LED for each filter group, 6W per LED lamp Yellow: 10W for each filter group: 5W per LED lamp Violet:6W LED for each filter group, 3W per LED lamp				
Observation	Fluorescence Bright field from microscope original light				
Screen	Digital screen show light intensity and remember light intensity of each color light source				
Operation	Rotating knob one step move different channels LED light source and filter cubes				
Power control	Rota-table knob, continuously adjustable brightness				
Input power	DC 12V 2A				
Shell	High rigid precision-cast aluminium with coating and vents				
Baffle	Orange color plastic light baffle				
Optional LED lamp and Filters					
LED	Filter type	Excitation filter	Dichroic mirror	Emission filter	
Blue	Blue Long-pass	460-490nm	>500nm	510nmLP	
Green	Green Band-pass	475/40nm	>500nm	535/45nm	
Yellow	Yellow Band-pass	560/40nm	>600nm	635/60nm	
Violet	Violet Band-pass	395/25nm	>425nm	460/50nmLP	
Red	Red Band-pass	620/50nm	>655nm	690/45nm	

Installation Cases



Olympus SZX7

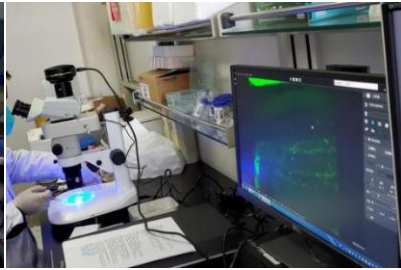

Olympus SZX7



Olympus SZX10

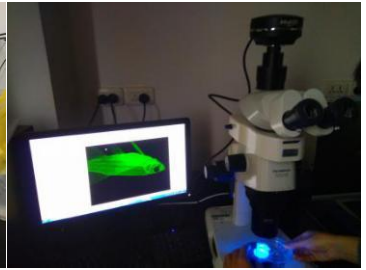

Olympus SZX16

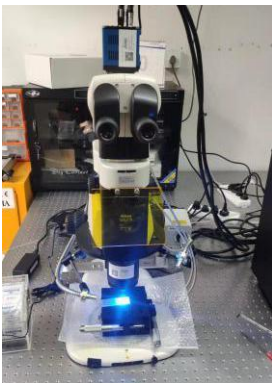

Nikon SZM18



Nikon SMZ800N



Nikon SMZ25



Leica M205C



Leica M6



Leica M80



Leica MZ16



Zeiss V8



Zeiss V8

TransGene Plants

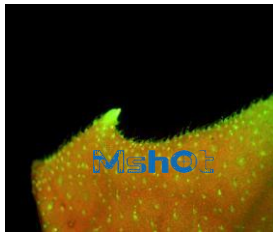

Leaf

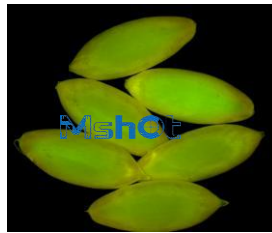

Cucumber seed

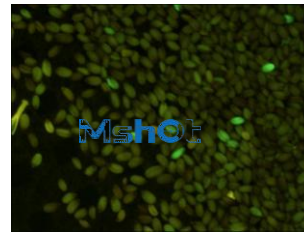

Rice seed

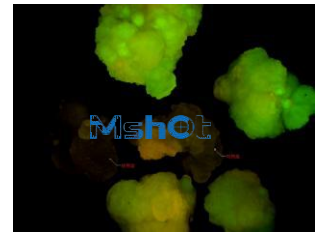

GFP seed

Zebrafish



Clip follicle



Zebrafish egg

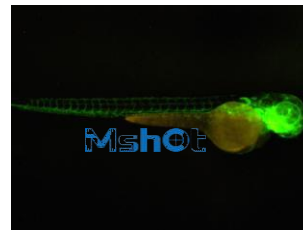

Grown zebrafish



Zebrafish cell

Little mouse

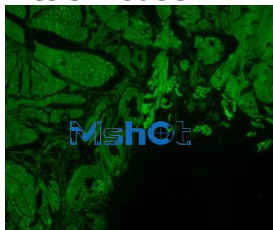

Intestine

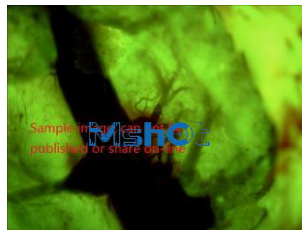

Heart thrombus



Intestine

Drosophila



Drosophila



Young worm



Fruit fly

C.elegant

