

Mshot

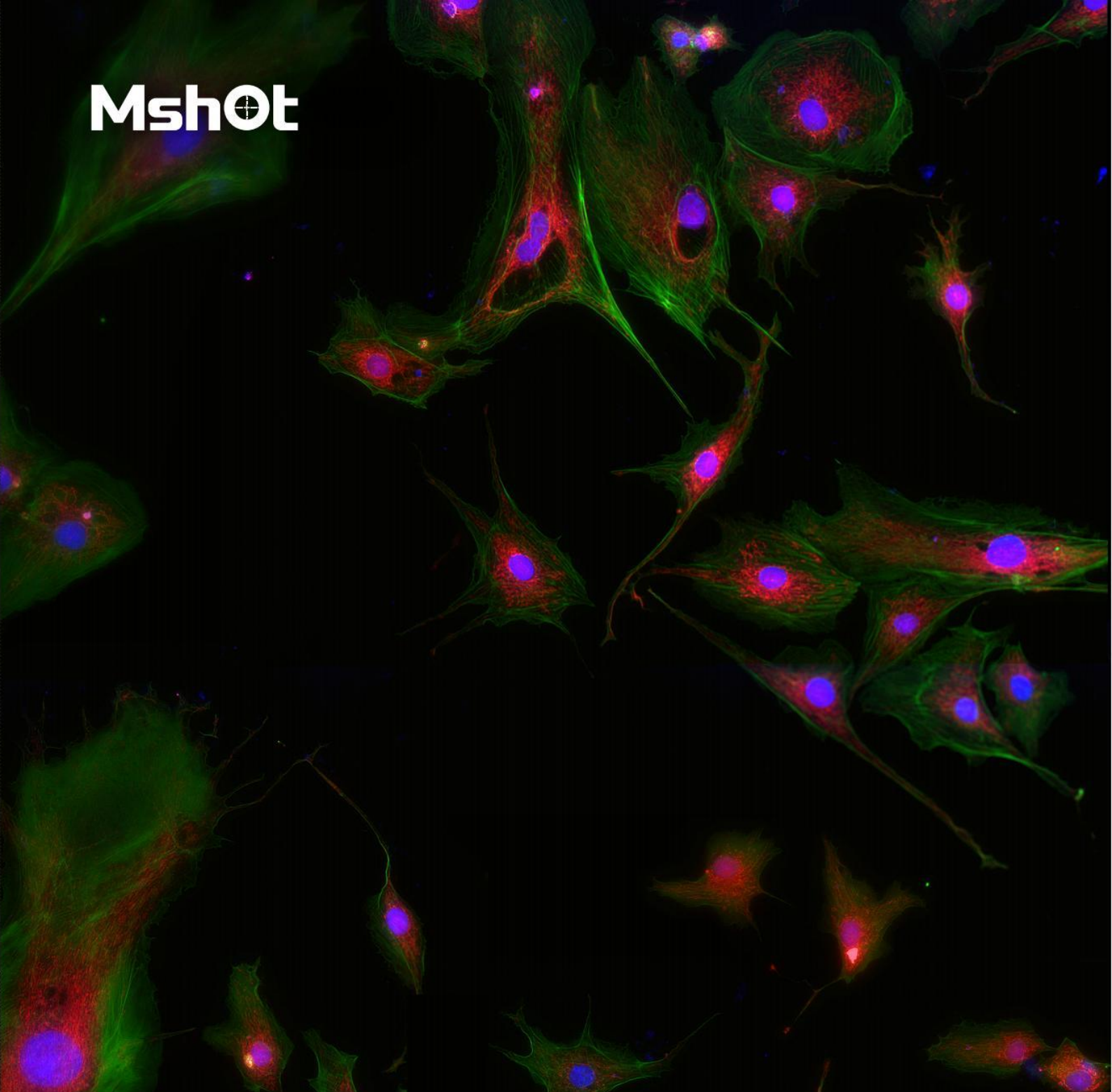

Inverted fluorescence microscope MIX60/MIX60-FL

Intelligent, high-performance cell observation protocol

Specialty cell culture solutions

Targeted optimization

Support phase contrast observation

Push-pull type phase contrast plate supports multiple magnification phase contrast observation, presenting clear morphology and details of live cell samples.

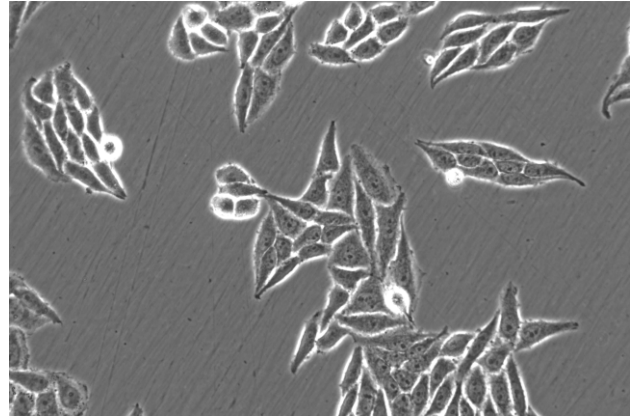
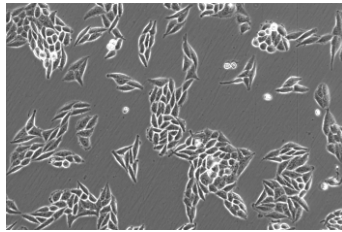

Flexible adaptation to culture vessels

The universal sample holder fits common culture containers. The stage can be expanded to 351mm x 251mm, flip-up design to accommodate large culture bottles and other containers.

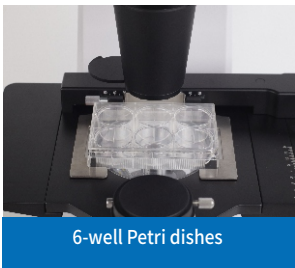

Supports multilayer cell factory

The 72mm long working distance condenser, larger working space, with a large stage, can be used to observe the "cellfactory" culture vessel within 10 layers.

ECO lights off when people leave

Embedded new sensor saving power and prolonging the life of the light source.

Digital LED screen, Visualization data

OLED screen shows the current chosen objectives, light intensity, the status of the light intensity manager.

Voice broadcast interactive function

Voice broadcast function is optional, the instrument can read out the objective type and zoom times, report when switching objective automatically.



Digital inverted fluorescence microscope

Precise repeatable fluorescence intensity

The modular inverted fluorescence microscope MIX60-FL adopts the LED fluorescence module to realize 3 channels fluorescence observation. The built-in OLED screen presents the current channel light intensity and independently memorized.

MIX60-FL

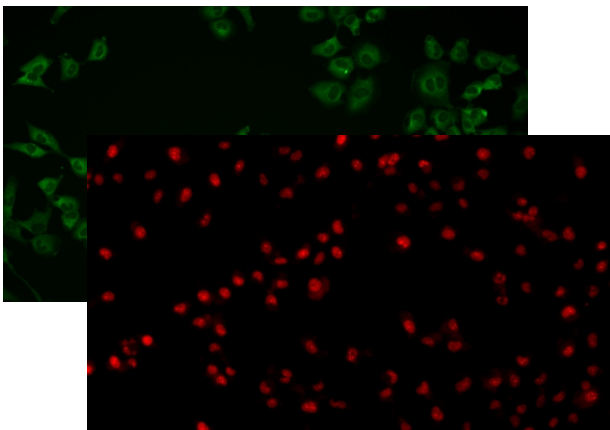

Various fluorescent labeled observations

The digital LED fluorescence module has three standard excitation cubes: DAPI(U), FITC(B) and TRITC(G) to meet the excitation needs of mainstream fluorescent dyes.

U	V	B	G	Y	R
DAPI	PacificBlue	FITC	Cy3	Texas Red	Cy5
Hoechst	Coumarin	GFP/EGFP	TRITC	mCherry	Draq5
AlexaFluor 350	BFP/EBFP	AlexaFluor 488	RFP	AlexaFluor 594	AlexaFluor 647
DyLight 350	DyLight 405	FAM	DsRed	ROX	DyLight 649

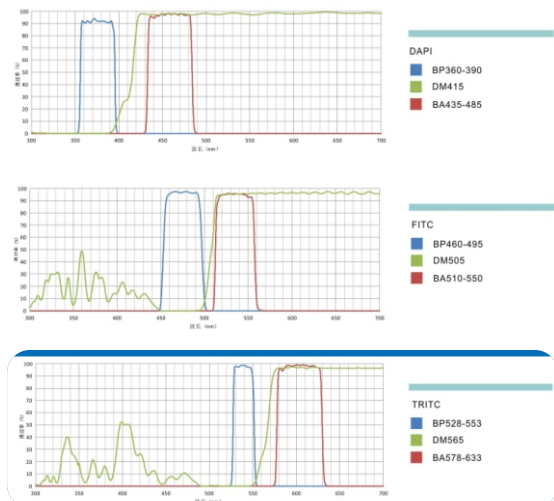

Various objectives configurations are available

- Plan achromatic objectives
- Plan achromatic phase contrast objectives
- Semi-apochromatic fluorescence objectives
- Semi-apochromatic fluorescence phase contrast objectives



MIX60-FL Specifications

Item	Specifications
Host	200mm infinity optical system, the body is equipped with ECO light-off function and can draw power
Eyepiece	SWF10X/22 plan eyepiece, high eye point, adjustable diopter
	SWF10X/23 plan eyepiece, high eye point, adjustable diopter (optional)
	Centering telescope
Eyepiece tube	Inclination angle 45°, interpupillary distance 53-75mm, body split ratio = 100:0 or 0:100
Nosepiece	Quintuple nosepiece, ball bearing with anti fungus device
Stage	Fixed stage size: 267.4mm×271.4mm
	XY stage moving ruler, mechanical movement, movement range: 110mm×75mm
	With stage expansion board
Universal sample holder	Match slides and different petri dish sizes
Drip board	Round transparent drip board: ϕ 118mm
Condenser	Numerical aperture N.A.: 0.3, working distance WD: 72mm
	Detachable condenser, container height \geq 19cm can be placed on the stage
Phase ring plate	10X ring, 20X/ 40X ring
Focusing mechanism	Coaxial coarse/fine focus, with tension adjustable and up stop, minimum division of fine focusing is 2 μ m.
Transmitted illumination system	3W full spectrum white LED, brightness continuously adjustable
	The filter holder can be inserted into ϕ 34mm color filters (blue, green, yellow, etc.) and is removable
	With aperture diaphragm, aperture blades, manual control switch
Digital display screen	Displays the current working status, including ECO, voice function, objective lens multiple and brightness, etc., and can perform voice broadcast of the current objective lens multiple.
Objective lens	Infinity Long Working Distance Plan semi-apochromatic Objective UPLFLN4X/0.13 WD: 17.15mm
	Infinity Long Working Distance Plan Achromatic Phase Contrast Objective Plan10X/0.25 PH WD: 4.1mm
	Infinity Long Working Distance Plan semi-apochromatic Fluor Objective Plan Fluor 10X/0.3 WD: 7.1mm
	Infinity Long Working Distance Plan semi-apochromatic Fluor Objective Plan Fluor 20X/0.45 WD: 5.9mm
	Infinity Long Working Distance Plan semi-apochromatic Objective Plan Fluor 40X/0.60 WD: 1.6mm
Fluorescence module	Standard B (460nm-490nm excitation), Y (540nm-580nm excitation), UV (330nm-380nm excitation) three fluorescence cubes

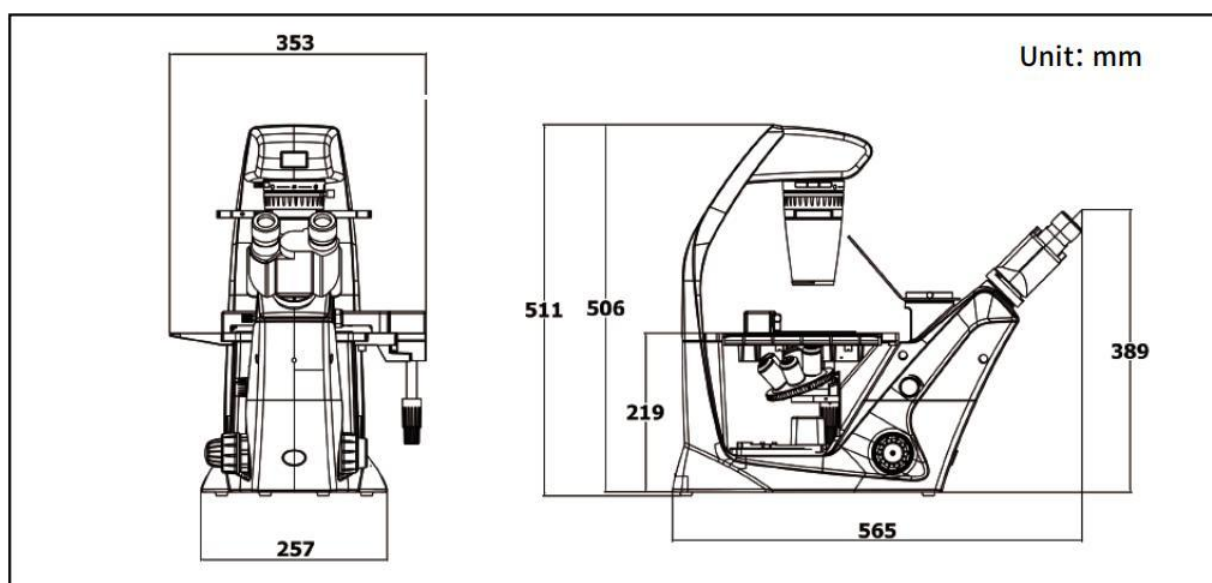

Reminder: Any specifications and appearance are subject to change without notice



Guangzhou Micro-shot Technology Co., Ltd.

Address: No. 1933, Huaguan Road, Tianhe District, Guangzhou, 506, Vanke Cloud Building A
 Website: www.m-shot.com / Email: sales@mshot.com

