



**MI52-N**

**Inverted Biological Microscope  
User Manual**

**Guangzhou Micro-shot Technology Co., Ltd**

**Website: [www.m-shot.com](http://www.m-shot.com)**

**Email: [sales@m-shot.com](mailto:sales@m-shot.com)**



# **Inverted Biological Microscope MI52-N**

## Thank you for buying our product!

This unit is a precision optical instrument. Though with high safety design, wrong usage and overlook of this manual can do harm to you and your property. Thus, to ensure the life of this unit and maintain it properly, please read this manual carefully before operating.

---

### Safety Reminder



**Warning!**

1. Be sure to turn off the power switch and remove the power cord before installing, replacing the bulb or fuse, plugging and unplugging the power supply.

To prevent electric shock or fire, be sure to turn off the power switch and remove the power cord before installing this unit, replacing the bulb or fuse, plugging and unplugging the power supply.

---



**Warning!**

#### 2. Do not disassemble

Except the removable parts mentioned herein, no part of this unit shall be removed, otherwise the performance of this unit may be reduced, or may cause an electric shock, injury or damage to this unit. Please contact the supplier if any fault occurs.

---



**Warning!**

#### 3. Input voltage

Check if the input voltage is consistent with your local voltage supply. If not, do not operate this unit and contact the supplier. Improper input voltage may cause a short circuit or fire thereby causes damage to this unit.

---



**Warning!**

#### 4. Use specific bulb, fuse and power cord

Use of an improper bulb, fuse or power cord may cause damage or fire to this unit. Any extended power cord used must be grounded (PE).

---



**Warning!**

#### 5. Protect this unit from high temperatures, dampness and foreign objects

To prevent short circuit or any other fault, do not expose this unit to any high temperatures or dampness environment for a prolonged period of time. A suitable operating environment is designated at a temperature of 5°C-35°C, and relative humidity of 20%-80% (at 25°C). If water splashes on this unit, turn off the power switch and remove the power cord immediately, and then wipe the water off with dry cloth. When any foreign object enters or drips onto this unit, please stop operating the unit and contact the supplier.

---



**Warning!**

#### 6. Heat of light source

The lighting bulb generates high temperatures during operation. Do not touch the collector lens or lamp box when the lamp is illuminated, and do not touch the bulb within 30 minutes after the lamp goes out due to high temperatures arising from operation. When replacing the bulb, make sure it has cooled down properly (the lamp should be off for at least 30min).

★ To prevent burn, do not touch the bulb when the lamp is illuminated or within 30min after it goes out.

★ To prevent fire, do not place any fibrous product, paper, flammable or explosive material (e.g., gasoline, petroleum ether, alcohol) near the halogen lamp housing or mercury lamp housing.

---



**Warning!**

**7. Coarse/fine focusing knobs**

This unit employs a coarse/fine coaxial focusing mechanism. Do not turn the left/right coarse/fine focusing knob in the opposite direction. When the objectives lifting device reaches the limit of motion, do not continue to turn the coarse focusing knob, otherwise the focusing mechanism may be damaged.

---



**8. Storage place**

This unit is a precision optical instrument, and improper operation or storage may cause damage or its precision may be adversely affected. Consider the following when selecting a storage place:

- ※ Avoid placing the unit under direct sunlight, directly under interior lighting or any other bright place.
  - ※ A suitable operating environment is designated at a temperature of 5°C-35°C, and relative humidity of 20%-80% (at 25°C). Do not expose this unit to high temperatures, dampness or dust for a prolonged period of time, otherwise mist or mold may develop or dust may deposit on the lens, thus cause damage to this unit and shortening its life.
- 



**9. Installation of bulb**

Do not touch the glass surface of the bulb directly with bare hands. When mounting the bulb, wear gloves or wrap it with cotton material.

- ※ Wipe off any dirt on the surface of the bulb with a clean cotton fabric dipped in alcohol. If the dirt is not thoroughly removed, it would etch the surface of the bulb weakening its brightness and shortening its life.
  - ※ Mount the bulb with care to avoid slipping off or injuries to your fingers.
  - ※ When replacing the bulb, make sure its contact is intact. If its contact is damaged, the bulb may be disabled or short-circuited.
  - ※ When replacing the bulb, the feet should be inserted into the holder as deeply as possible. If the feet are not tightly inserted, the bulb may go out or short circuit.
- 



**10. Instrument handling**

This precision optical instrument is heavy and should be handled with care. Strong impact and rough handling are strictly prohibited, it may cause damage to this unit.

---



**11. Environmental protection**

Please dispose the wastes from the packaging and operation of this unit by category such as carton, foam, plastic, bulb and etc. Do not discard the damaged mercury lamp carelessly in order to avoid creating environmental poll

## Content

<b>I. Characteristics and application .....</b>	<b>5</b>
<b>II. Structure and features.....</b>	<b>1</b>
<b>III. Installation.....</b>	<b>1</b>
<b>IV. Technical specification.....</b>	<b>3</b>
<b>V. Operation.....</b>	<b>4</b>
• <b>Bright field observation.....</b>	<b>3</b>
• <b>Phase contrast observation.....</b>	<b>8</b>
• <b>Operation of the photographic device.....</b>	<b>9</b>
<b>VI. Replace Bulb and Fuse.....</b>	<b>9</b>
<b>VII.Maintenance.....</b>	<b>9</b>
<b>VIII.Troubleshooting.....</b>	<b>9</b>



## I. Characteristics and application

MI52-N inverted biological microscope adopts excellent infinity optical system with long WD plan field objective and WF eyepiece. Stable and compact body along with high rigidity prevents it from shaking when observing. The rotary in-and-out condenser enables it to do non-infected culture cell observation in high culture dish and cylindrical flask. The machine can be applied in cell tissue and transparent liquid tissue observation, as well as bio-medical, medical detection and disease prevention.

## II. Structure and features

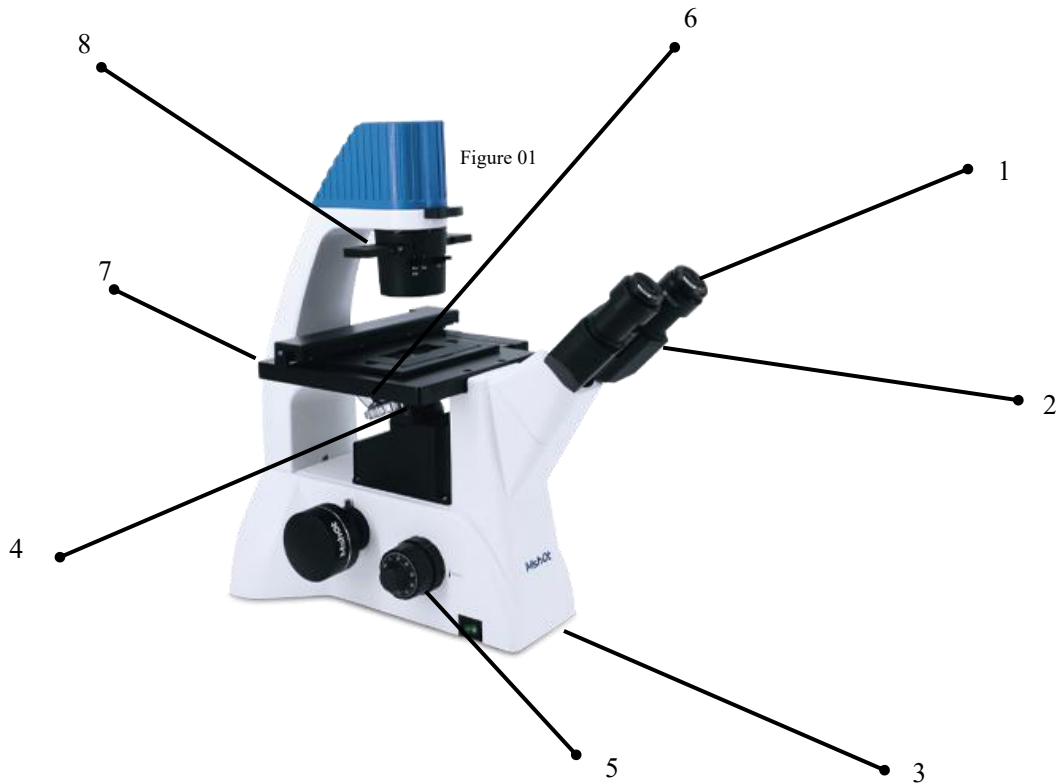

1. Eyepiece 2. Observation head 3. Host 4. Objective nosepiece 5. Coarse/fine focus 6. Objective 7. Stage 8. Insert plate condenser

### III. Installation

#### 1. Installation steps and approach

- (1) Remove the package. Take out host 3 and put it stably on the operation table. Take off related support and anti-ash cover.
- (2) Take out binocular eyepiece 1. Take off the anti-ash cover. Install it on the observation socket 2 Lock the head.
- (3) Take off dust cover cap from eyepiece holder, put two eyepieces 6 into the holder and rotate to make them matched well
- (4) Unload the moving board and put the round glass stage board in the middle of the stage if not needed.
- (5) If the moving board is needed (default with installed from factory), select suitable culture dish board and put it in the moving board frame.
- (6) Connect power line to microscope body and check if all setup are safety.
- (7) Power on
- (8) Check all accessories and tools come together, well keep and store them.

### IV. Technical specification

Eyepiece	Wide field SWF10X(field number:Φ22mm), high eyepoint, one diopter adjustable	
	Centering telescope	
Observation tube	45° inclined, interpupillary distance 53~75mm, diopter adjustable	
Infinity plan achromatic objectives	Bright field	PLL 4X/0.12 Work distance:10.8mm
		PLL 40X/0.55 Work distance:2.5 mm
	Phase contrast objectives	PLL 10X/0.25 PHP Work distance:4.1 mm
		PLL 20X/0.45 PHP Work distance:5.0 mm
	Optional bright field objectives	PLL 10X/0.25 Work distance:4.1mm
		PLL 20X/0.45 Work distance:5.0 mm
PLL 40X/0.55 Work distance:2.5 mm		
Phase contrast ring plate	10X, 20X and 40X in one unit	
Focus system	Coaxial coarse/fine focus, with tension adjustable and up stop, minimum division of fine focusing is 2μm.	
Nosepiece	Quintuple nosepiece,ball bearing with anti fungus device	
Stage	Fixed stage overall size is 227mmX208mm	
	Glass rotundity stage overall size is Φ118mm, inner size is Φ68mm	
	Mechanical moving device, moving range is 77mm (longitudinal)X135mm (transverse)	
	Culture dish holder 1	Inside locating slot size: 86mm (W)X129.5mm (L), (suitable for circular culture dish Φ90mm)



	Culture dish holder 2	Inside locating slot size: 34mm (W)X77.5mm (L), (suitable for circular culture dish $\Phi$ 68.5mm)
	Culture dish holder 3	Inside locating slot size:57mm (W)X82mm (L), (suitable for circular culture dish $\Phi$ 60mm)
	Culture dish holder 4	Inside locating slot size:29mm(W)X77.5mm (L), (suitable for circular culture dish $\Phi$ 35mm)
Transmitted illumination system	White LED lamp with brightness adjustable	
	Push-pull type condenser, working distance 55mm	
Camera adapter	Internal set 0.75X C-mount	
Tool	Allen driver	
	Dust cover	

## V. Operation

- **Bright field observation**



Check if the input voltage is consistent with your local voltage supply. If not, do not operate this unit and contact the supplier. Improper input voltage may cause a short circuit or fire thereby causes damage to this unit.

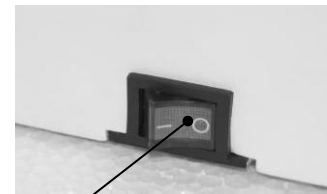

1

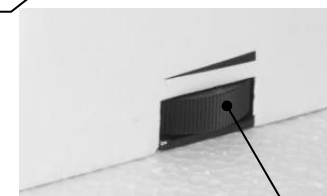

Figure 03

2

1. Turn on lightening switch and adjust brightness

Turn on switch 1 (turn to “-” ), adjust knob 2 to get suitable light for observation. (Figure 03)

### **Caut ion**

Long-term high brightness would do harm to the life of the bulb.

Turn down the brightness when not used to protect the unit.

1. Adjust condenser riser



Figure 04

Slider type condenser device, please put on phase contrast condenser 1 into the central place of light path, as figure 04 shows.

### 3.Reset diopter ring

Rotate the diopter ring 1, leave the FOV “0” align at the side mark line. (Figure05)

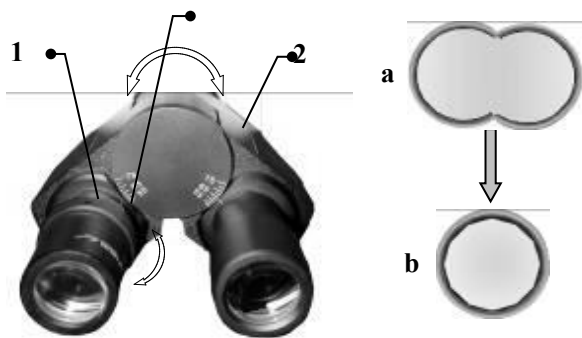

Figure 05

### 4.Adjust Pupil Distance (PD)

This is for more comfortable and clearer observation. If the field appear two crossed circles as figure 05-a, rotate lens 2 to change the exit pupil center distance to reach a coincident circle as figure 05-b.

### 5. Place the specimen section or the dish

1) To observe the specimen on the slide, put the slide on the dish board directly. To observe culture tissue in the dish, change the board according to the size of the dish.( Refer to the specification figure) See Figure 06.

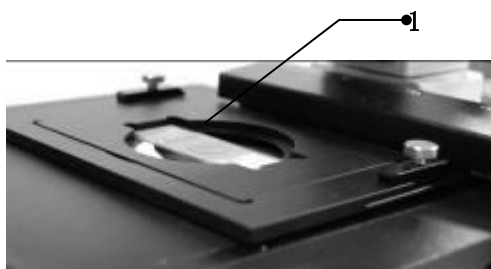

Figure 06

2) Adjust the hand-wheel 1 and 2. The observation area should be right above the objective for convenient observation.

See figure 07.

#### 6. coarse/fine focusing

(1) Use the 10X objective to focus

Rotate the nosepiece 1; put the 10 x objective in the light path. See figure 08.

(2) Rotate the coarse hand-wheel 3 or 6; raise the objective to the peak. Observe with the eyepiece, lower the objective using the coarse hand-wheel until the specimen image appears. See figure 08.

(3) Adjust hand-wheel 2, make the image clear. See figure 08.

(4) Lock the spacing hand-wheel 5 as figure 08 shows.



Figure 07

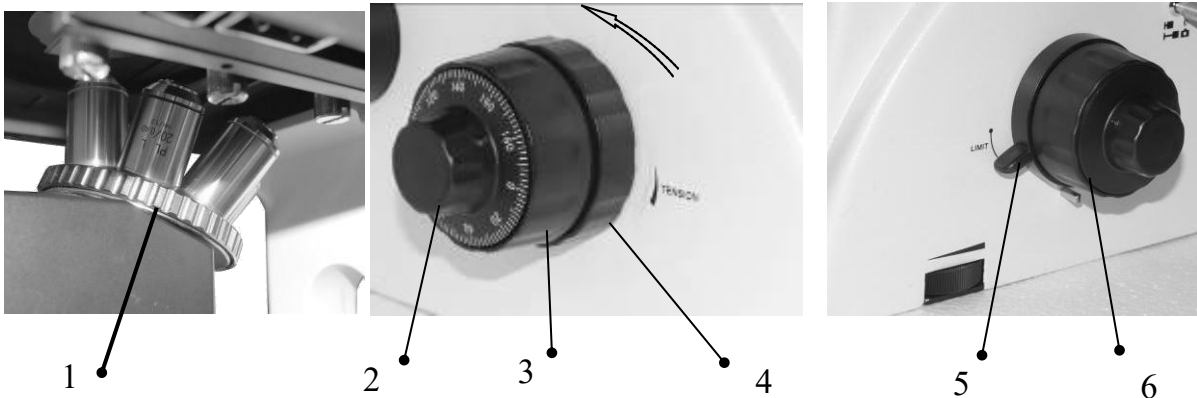

Figure 08

### Caution

Use the 10X objective to focus and set location. When change to higher magnification, use the coarse hand-wheel to raise the objective to the location directly and then use the fine one to adjust.

5) Coarse hand-wheel tightness adjustment: The coarse hand-wheel 3 or 6 has been preset to a suitable place. If needed, use the hand-wheel 4 to adjust.

### Notice

It will hard to work if adjust coarse focusing too much.

#### 7. Adjust, load and unload stage moving board

(1) Stage moving ruler 1 (Y) and (X) direction moving is controlled by hand wheel 2 and 3, as figure 09.

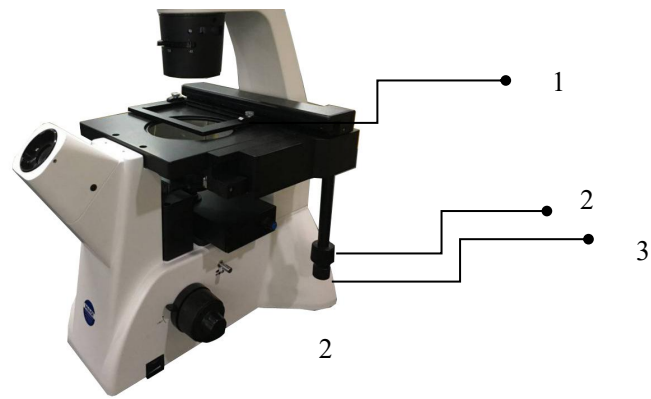

**Notice**

It will caused self protected Figure 09 1 moving stage ruler moved to its limitation, components will rub against each other and lead the stage stop working.

(2) Unload the moving board 1 when observe culture tissue in large dish. When unload, please put condenser system 4 out of the light path, take out the dish board and lower the objective. Unscrew the screw 5, place upside down on working platform, it can not put sidelong, or it might be damaged . See figure 10.

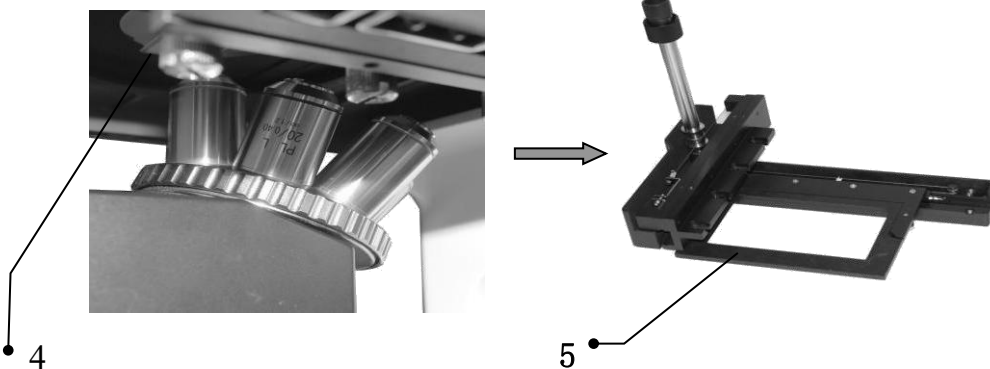

Figure 10

**Notice**

Moving stage ruler is the key parts to hold slider and sample, it can not put sidelong or without anything to support it on back after unload, please put it upside down stable, or it be damaged on accuracy.

(3) Tightness adjustment

It has been adjusted well from factory. If needed after long time using, unload the ruler, reverse it and do the steps below.

(a) Y direction

Unscrew screw 4, unload the supporting board 3, unscrew the two screws 1 (a little bit) and then adjust screw 2 with Allen wrench to adjust the tightness of Y transmission steel rope. See figure 11-a.

(b) X direction

Unscrew the two screws 5 and adjust screw 6 to adjust the tightness of X transmission steel rope. See figure 11-b.

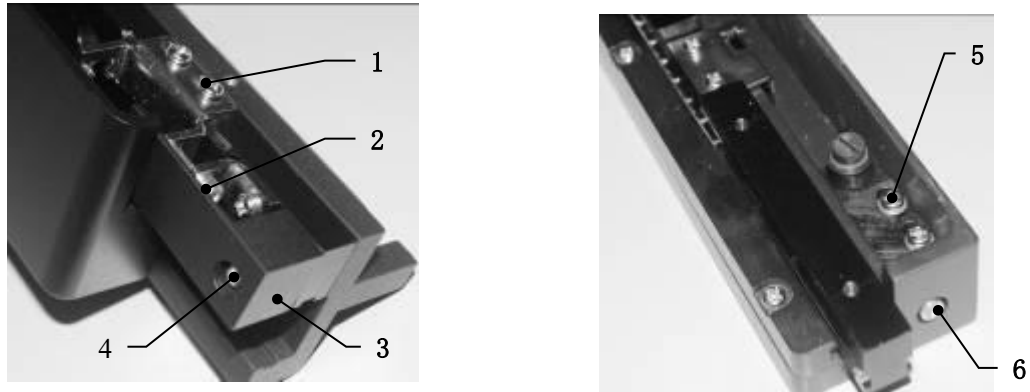

Figure 11

(4). Diopter regulation

a

Use the diopter ring 1 on the left lens to adjust diopter.

(a) Put the 40X objective in the light path, observe with right eye and adjust till the specimen image is clear.

(b) Do the same step on left. The diopter range is  $N = \pm 5$ . See figure 12.

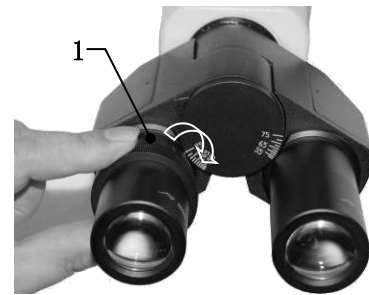

Figure 12

#### ● Phase contrast observation

Caution

The objective should coincide with the plate in the condenser; otherwise the effect of imaging would be worse.

1. Put specimen

Put the specimen on the stage board or directly on the stage, focus till the image clear.

2. centering

1) Take out one of the eyepieces, insert the centering eyepiece 2 into the lens as figure 13-a.

2) A dark ring 5 and a bright ring 6 would appear in the field as figure 13-c.

3) Adjust ring 1 if the edge of the dark or bright ring is not clear.

4) Adjust the plate as figure 13-c shows if the two rings do not coincide with Allen wrench 3. Adjust screw 4 if it is a pull-plate one. See figure 13-d.

5) After centering, take out centering eyepiece. And insert observation eyepiece again.

**Caut ion**

Centering again when change magnification to ensure the imaging effect.

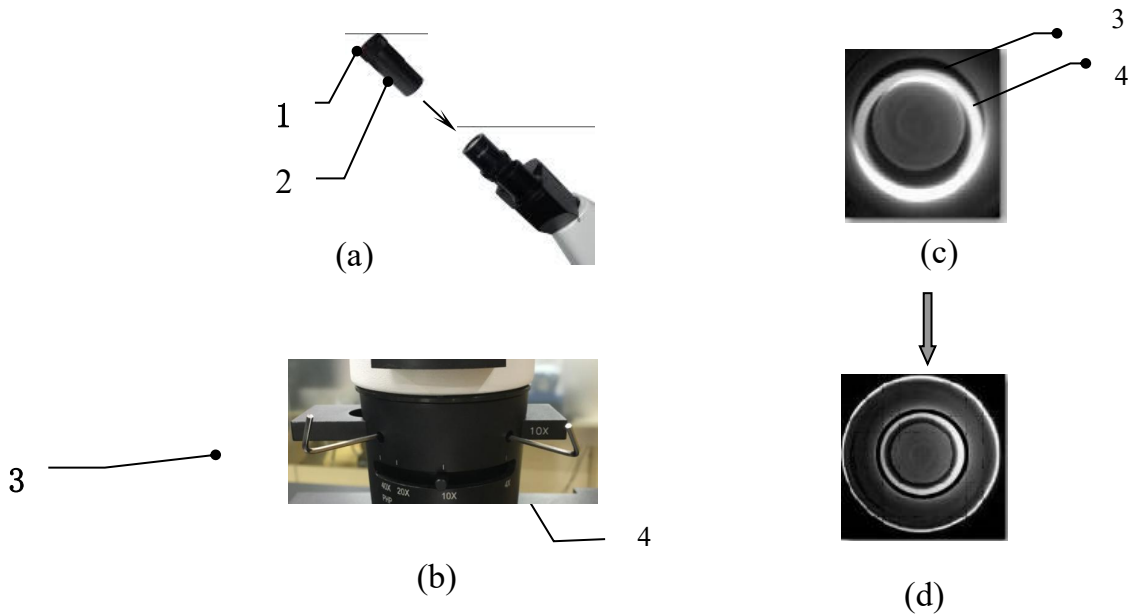

Figure 13

### • Operation of the photographic device

The push/pull rod is used to switch observation/camera. The camera output interface is on the left of the body. Operation as below:

1. Unscrew screw 1 on the camera interface, take out the cover 2, see figure 15.
2. Set up the adaptor on the output interface, lock the screw. Turn on the camera and make it work.
3. Put the 10X objective in the light path.
4. Push the rod 3, observe the specimen and adjust till the image clear.
5. Pull the rod 3; watch the monitor to check is the image is clear. If not, adjust fine knob.
6. For higher synchronization demanded, do below.

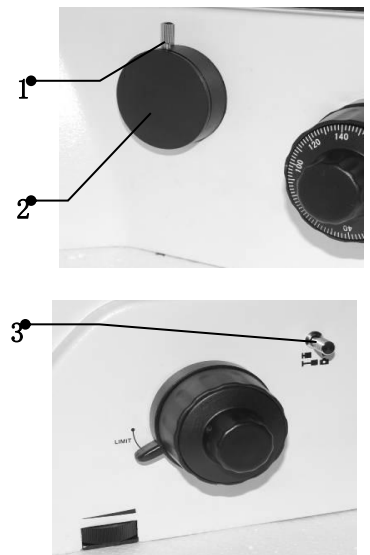

Figure 15

- 1) Push rod 3, observe specimen image. Find a target (a target easily to be recognized, as S in figure 16-a) and remove it to the field center. Remove it to the cross point of the graduation eyepiece if you have as figure 16-b.
- 2) Pull rod 3, watch the image on the monitor and check if the target above is near the field center. If it is a long distance, adjust the three screws on the output interface and remove the target to the center.

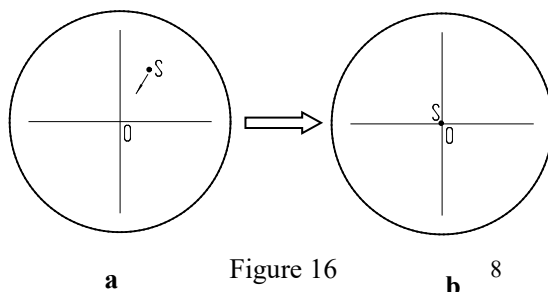

Figure 16

- 3) Move the specimen and check if the moving direction coincides with that of the monitor image. If not, adjust the camera direction. Unscrew the screws on the interface, rotate the camera and make the two directions the same and finally lock the screw.

## VI. Replace Bulb and Fuse



### Warning!

Turn off the power switch and unplug the power cord before replacing the bulb and the fuse, otherwise fire, personal injury or damage to this unit may occur due to electric short circuit.

This instrument fuse is used to light for transmitted lighting system, fuse\_3 is integrated at the input power adapter of host, as figure 17.

### 1. Replace transmission illumination halogen bulb

- (1) Turn off the power switch 1, and unplug the power cord 2, as figure 17.
- (2) Take out fuse basement 2 by flat screwdriver 1 as image shows, then take off broken fuse and insert new fuse, out the fuse basement back to host input power adapter.
- (3) Re connect power to check if it works well.

### 2. Replace body fuse

The fuse is installed in the fuse socket 3, replace according the following steps.

- (1) Turn off the power switch 1 and unplug the power cord 2. See Fig. 29.
- (2) Loose the fuse socket nut 2, remove the damaged fuse and replace a new one. See Fig. 30.
- (3) Connect the power cord and turn on the power switch to check whether the fuse works.

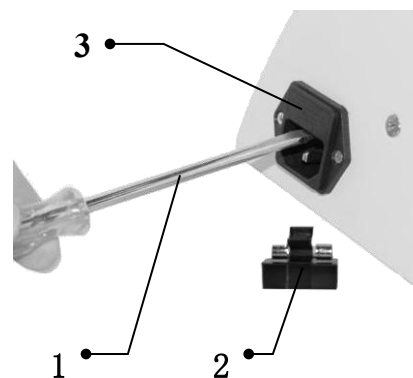

Figure 17

## VII. Maintenance

1. The power switch of the main unit is the power control. When finish using this unit, press the switch to “0” to cut off the power supply, unless the electric component in this unit is still operating. When this unit is not to be used for a long time, remove the power plug from the supply socket and keep all cables properly.
2. This unit should be kept clean. Remove any oil on the lens and clean the body with clean gauze (or silk fabric or absorbent cotton) dipped with a little alcohol. Put on the dust shield until this unit is completely cool and dry.
3. Cleaning the lens surface  
Blow off or wipe off any dust on the lens with a blower ball or a soft brush; heavy dirt and fingerprints can be removed with lens tissue or soft cloth dipped with a little mixture of alcohol and ethyl ether gently (the mix ratio is: alcohol 20-30% and ethyl ether 70-80%).

**Caution**

Wiping in direction shown on the right is easier to clean.



WRONG

RIGHT

4. Cleaning the surface of this unit: Wipe it with clean soft cloth; heavy dirt may be wiped off with a neutral detergent.
5. Keeping: When this unit is not to be used for a long time, turn off the power supply of this unit, allow the bulb to cool down sufficiently, put on the dust shield, store this unit at a dry, ventilated and clean place free from any acid, alkali or steam, otherwise mold may develop on the lens.
6. Periodic inspection: This unit should be inspected and maintained periodically to maintain its performance.

**Caution!**

Do not wipe this unit with any organic solvent (e.g., alcohol, ethyl ether or its dilute solution), otherwise the surface paint of this unit may come off. It is suggested that a layer of non-corrosive lubricant is applied on the moving parts of this unit before the dust shield is put on, and place the eyepiece and the objectives in a container with desiccant.

**VIII. Troubleshooting**

	<b>Fault</b>	<b>Cause</b>	<b>Disposition</b>
Electronic system	No light shown in the field of view	The power switch is not turned	Turn on the power switch.
		The fuse is damaged.	Replace the fuse.
		The connector of the electric chassis is in bad contact.	Check and have professional repair it.
Optical and imaging device	Fluorescence attachment can not be put into the microscope slot, has dark area in the field of view or lighting is not even, can not see full field of view.	Attachment converter is not in the right position	Recheck converter position
		Objective, eyepiece or condenser is not clean	Clean lens by alcohol-metabolic or change new lenses
		Nosepiece position is not right	Lift nosepiece to the highest position
		Attachment has not been set properly	Push the attachment stick the slot surface
		Slider loosen	Tighten slider draw in clockwise
	Oil or dust is found in the field of view.	There is oil or dust on the eyepiece lens.	Wipe the eyepiece.
	Defocusing or low resolution	The objective is damaged.	Repair the objective (by a professional).
There is oil or dust on the surface of		Wipe the objective or the eyepiece.	



		the lens of the		
		The aperture of the aperture diaphragm is too small.	Adjust the aperture of the aperture diaphragm based on the objective magnification (or numerical aperture) used.	
		The objective deviates from the light path.	Turn the nosepiece to the fixed position.	
		Sample slider cover glass is too thick or thickness	Prepare sample slider according to objective parameters	
	The focal plane of the image is inclined (brighter on one side and darker on the other)。	The lighting bulb is seriously inclined.	Reposition the lighting bulb.	
		The specimen is not laid flatly.	Lay the specimen flatly on the object stage and hold it stably.	
		Surrounding is too bright	Create darker surrounding when observing fluorescence	
	Phase contrast performance is not good enough	Phase contrast condenser is not matched with phase contrast ring	Choose matched times phase contrast condenser and phase contrast ring	
		Phase contrast plate central is out of phase contrast condenser light center	Adjust phase contrast center to make two light circle overlay to each other.	
		Sample is not suitable for phase contrast observation	Change suitable sample	
	<b>Mechanical system</b>	The image cannot remain clear during observation.	The focusing mechanism flows (slides down) automatically.	Adjust the coarse adjusting hand wheel.
			The fine focusing mechanism fails	Check and have professional repair it.
			The stage loosens or is inclined.	Check and have professional repair it.
Condenser lifting system can not be set or not accuracy		Set screw loosen	Re set screw	
		Lock device is too old	Check and have professional repair it.	
Mechanical stage		Y direction moving is too slightly and leads X direction moving at the same time.	Adjust Y direction driver wire tightness	

		X direction moving is too slightly and leads Y direction moving at the same time.	Adjust X direction driver wire tightness
		Driver wire break	Change new driver wire requires professional workshop to repair it.